



**Motic®**

MORE THAN MICROSCOPY

# AE2000

Routine and Live Cell  
Microscope  
Solution



# AE2000

## Routine and Live Cell Microscope Solution

**M**otic's new **AE2000 Inverted Microscope** is the ideal instrument for routine live cell inspection in both educational and high grade professional applications.

Uniquely integrated features like the Ergo tube and Auto cut-off mode ("sleep mode") are focused on enhancing its performance during the rigors of daily use.

Designed for routine-lab or clinical work, as well as research requirements in Pharmaceutical Laboratories or Universities, the AE2000 is more than capable of fulfilling the expectations of its users. Superb optical quality can be expected from a brand new optical series of both bright field and phase contrast lenses, following Motic's proven successful CCIS® Infinity Optical System.







## Stands

Designed as a basic instrument for any life-science laboratory, the AE2000 comes in **three different stand types**. Besides the standard **Binocular and Trinocular versions**, Motic is proud to present an astonishing ergonomic solution not before offered within this class of microscope: a **Binocular Ergo model**. The Ergo stand allows an adaptation of the viewing angle to the personal demands of the individual user, especially useful over prolonged hours of viewing.

With a surprisingly small footprint, Motic's AE2000 fits easily into every laboratory even when space is limited. A **robust design and solid manufacturing** ensure a long working life time even under rough usage conditions. Easy reach of both focusing and illumination controls guarantee comfortable operation for many hours.

*Located at the back of the stand, a **built-in carry handle** offers easy transportation when needed.*

## Eyepiece tubes

Depending on the working environment and its demands, the AE2000 Series has a solution. Each eyepiece tube allows a **360° swiveling** movement as well as a flexible adjustment of the **interpupillary distance between 48 and 75mm**. The “**Butterfly mode**” increases the viewing height by 40mm.

The reasonable beam split of 20:80 in the trinocular tube allows the adaptation of any modern documentation device. For the most demanding imaging applications, Motic offers a complete range of Moticam cameras, in both affordable CMOS and scientific grade CCD options.

Designed with a comfortable viewing angle of 45°, all AE2000 eyepiece tubes (Binocular, Trinocular and Ergo) offer a **20mm Field of View (FOV 20)**. The **binocular Ergo version** gives the user the additional freedom to vary the standard viewing angle in a range of +/- 15°, allowing in total a **30°- 60° angle**.



Butterfly movement



360° Swiveling movement



AE2000 with Ergo-head



## Eyepieces

In the AE2000, Motic's Infinity Corrected CCIS Optical system displays a field flatness of 20mm. The high eye point principle of the AE2000's eyepieces **ensure true colour and sharp images**, while **minimizing eye fatigue and strain**. The **diopter adjustment** of each eyepiece is an integral part to help spectacle wearers, in addition optimizing reticule usage.

Besides the standard 10X eyepieces, the AE2000 series also offers higher magnification eyepieces.

Description	F.N.
Widefield N-WF 10X	20
Widefield N-WF 12.5X	18
Widefield N-WF 15X	16

## Eyepiece reticules

In the Motic AE2000 a variety of **reticules for measuring purposes** are available. These include:

**Special reticules are also available on request**

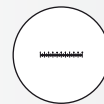

Graduated  
linear hair point =  
0.1mm/10mm

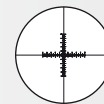

Graduated  
cross hair point =  
0.1mm/10mm

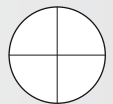

Plain cross hair

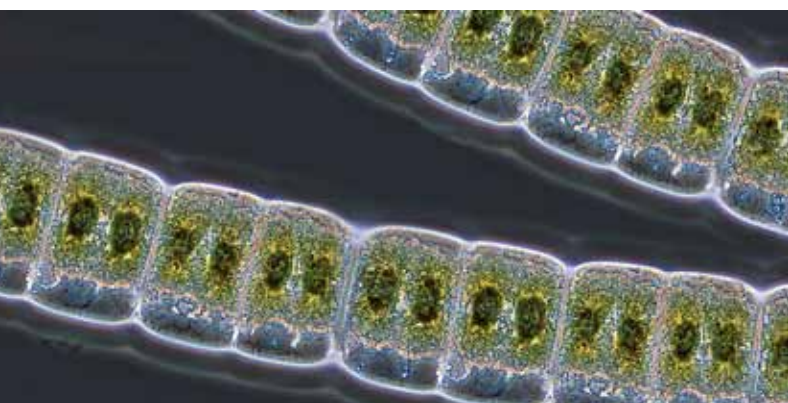

## Nosepiece

The AE2000's ball bearing nosepiece ensures parcentration and repeatability with every objective change. A **side faced orientation** of the **quadruple nosepiece** allows an easy view on the lenses used and a simple manual change of magnification.

When dealing with liquids the **sealed nosepiece** prevents any fluid spills from getting into the inner instrument mechanics.

## Objectives

With the release of the new AE2000, Motic has achieved a **new standard in optical design** and development. The AE2000 offers a completely upgraded class of **Plan Achromatic lenses within the CCIS Infinity Optical concept**. This upgrade covers a complete range of the following magnifications for bright field and phase contrast: 4X, 10X, 20X and 40X. New in this level of microscopy is the special designed 4X Phase objective for fast overview and screening examinations.

An optimized multi-layer coating for **improved contrast** as well as carefully selected glass quality for **better transmission** lead to **significantly brighter and sharper images**. Motic is pleased to offer these newly developed optics with the **RoHS standard for lead-free manufacturing**, ensuring all of its new products meets the highest standards possible for both environment and user safety.



Magnification	N.A.	W.D. (mm)
Plan Achromat PL 4X	0.10	12.6
Plan Achromat PL 10X	0.25	16.8
Plan Achromat LWD PL 20X	0.30	4.7
Plan Achromat LWD PL 40X	0.50	3.0
Plan Achromat Phase PL Ph0 4X	0.10	12.6
Plan Achromat Phase PL Ph1 10X	0.25	4.1
Plan Achromat Phase LWD PL Ph2 20X	0.30	4.7
Plan Achromat Phase LWD PL Ph2 40X	0.50	3.0
Plan Achromat Phase LWD PL Ph1 20X*	0.30	4.7
Plan Achromat Phase LWD PL Ph1 40X*	0.50	3.0

\* Will be released in 2011



## Stage

The convenient low positioned stage for optimized viewer posture and easy access has a new **hard-coated surface** for easy cleaning. All standard packages contain a **glass stage insert** as well as a **new metal insert**. Due to an orientation pin in the metal stage insert the movement of the objectives when changed follow exactly the shape of the semi-circular hole, preventing damage of the front lens.

To enlarge the standard size of the stage (200 X 239mm), auxiliary extension plates are available. This allows the width of the working plate to be extended up to 333mm. The optional mechanical stage can be supplied with inserts for the more common cell culture vessels, and standard glass slides.







Phase ring set



## Condenser

The resolution power of a microscope is deeply depending on an optimized condenser system. Motic's AE2000 offers a clever concept to find **the best compromise between working distance and illumination quality**.

The dovetail mounting of the condenser allows a **quick change between the two condensers**. Surprisingly Motic's concept has **one phase ring set**, covering both condensers and thus ensuring maximum flexibility. When the condenser is removed, **the maximum free working distance is 184mm**.



Halogen bulb

LED module



## Illumination

One of the first impressions of the Motic's AE2000 is a **significantly brighter and more even illuminated image**. The light management of both **Halogen and LED versions** has been improved in terms of transmission rates and optimization of the light path. Standard packages come with a 6V/30W Halogen illumination, which will give sufficient power throughout the complete line of objectives offered - especially for the light consuming PH40X.

The AE2000 also supports the most recent requirements for LED illumination by a **simple replacement of the Halogen bulb by a small LED module**. One of the main advantages of LED, the extreme reduction of heat development, can now be achieved for the essential study of living samples.

As a new safety precaution Motic has implemented a **"sleep mode"** on the AE2000, **based on an IR-sensor**. **This motion sensor detects a user** in front of the microscope and automatically turns off the microscope when it is left for **more than 15 minutes**. By returning to the instrument, **the power is reactivated** - effectively making the new Motic AE2000 a **"power-smart" microscope**.

GOINGgreen





## CCD Adapter

Newly designed CCD adapters, following the **ISO standard** of 38mm diameter, have improved optical characteristics to enhance image reproduction quality.

The appropriate adapter has to be chosen in relation to the chip size of the used digital camera. The following “magnifications” are available: 1X, 0.65X and 0.5X.





# Documentation

Today accurate documentation is becoming an increasingly important part in most if not all natural science applications.

In the new AE2000 system the end-user may choose between several different imaging options.



## Standard Photomicrography

The traditional use of a **single lens reflex camera**, today mostly digital, requires the trinocular version of the AE2000. The adaptation of the camera consists of a **mechanical adapter** combined with a **photo eyepiece** (2.5X or 4X). The necessary **T2 adapter** referring to the camera model is supplied by the **camera manufacturer**. This setup delivers **high resolution images of small fields**.

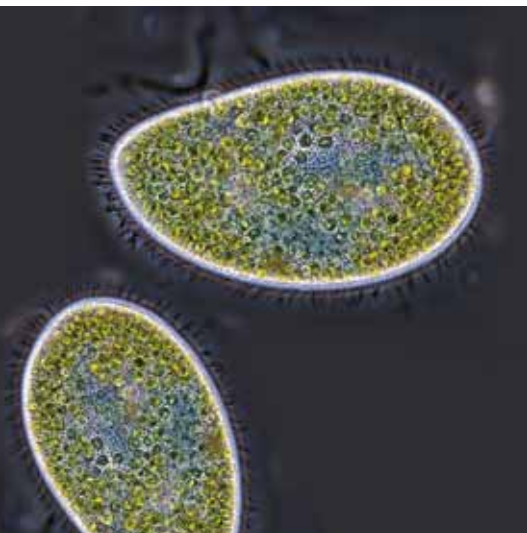

## Digital Documentation

A more convenient setup is provided through Motic's philosophy of easy image digitalization. The combination of the AE2000 with a member of the **Moticam series** of digital cameras delivers **excellent live images, which can easily be stored for future usage**. All Motic cameras come equipped with software to transform the AE2000 into an analysis and documentation workstation.

Motic offer a complete range of digital cameras, starting with a basic resolution of 1.3MP (CMOS) up to the **research grade Moticam Pro Line** (CCD) with a maximum of 5MP, including **Monochrome and Cooled versions**. These Moticam cameras deliver sharp live images with easy post-capture handling.

For further details on our range of cameras, as well as on adaptation questions, please contact your nearest Motic office or your local authorized Motic Professional reseller.

## AE2000 Standard Specifications

<b>Model</b>	AE2000
<b>Optical System</b>	Colour Corrected Infinity Optical System [CCIS®]
<b>Observation Tube</b>	Widefield binocular 45°, 360° Swiveling Widefield trinocular 45°, 360° Swiveling, light distribution 100:0/20:80 Widefield binocular Ergo 45°, +/- 15°, 360° Swiveling
<b>Eyepieces</b>	Widefield high eyepoint, N-WF10X/20mm, with diopter adjustment
<b>Nosepiece</b>	Left side orientated, quadruple
<b>Stage</b>	200X239mm surface
<b>Condenser</b>	ELWD N.A. 0.3, working distance 72mm. Without condenser: working distance 184mm
<b>Focus</b>	By nosepiece movement, 8mm Coaxial focusing knobs Coarse focus with torque adjustment Fine focus with 2µm minimum increment
<b>Illumination</b>	6V/30W Quartz Halogen illumination with intensity control, or 3W LED

## AE2000 Schematic Diagrams

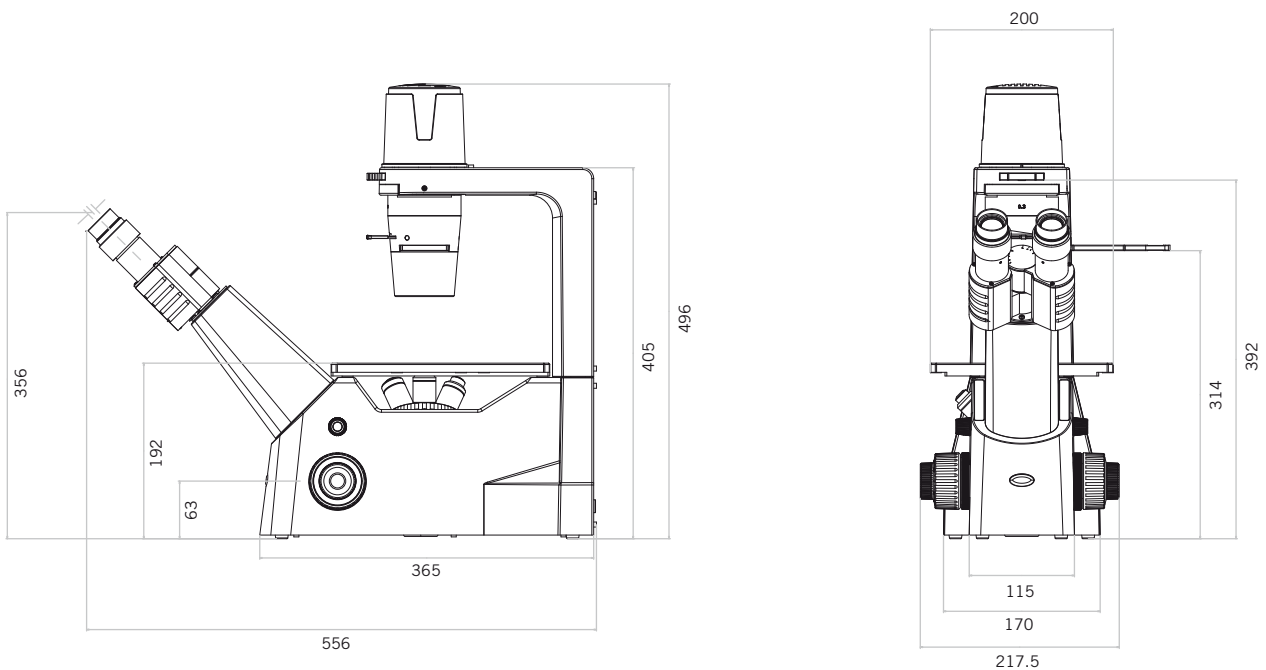

# AE2000 System Diagram

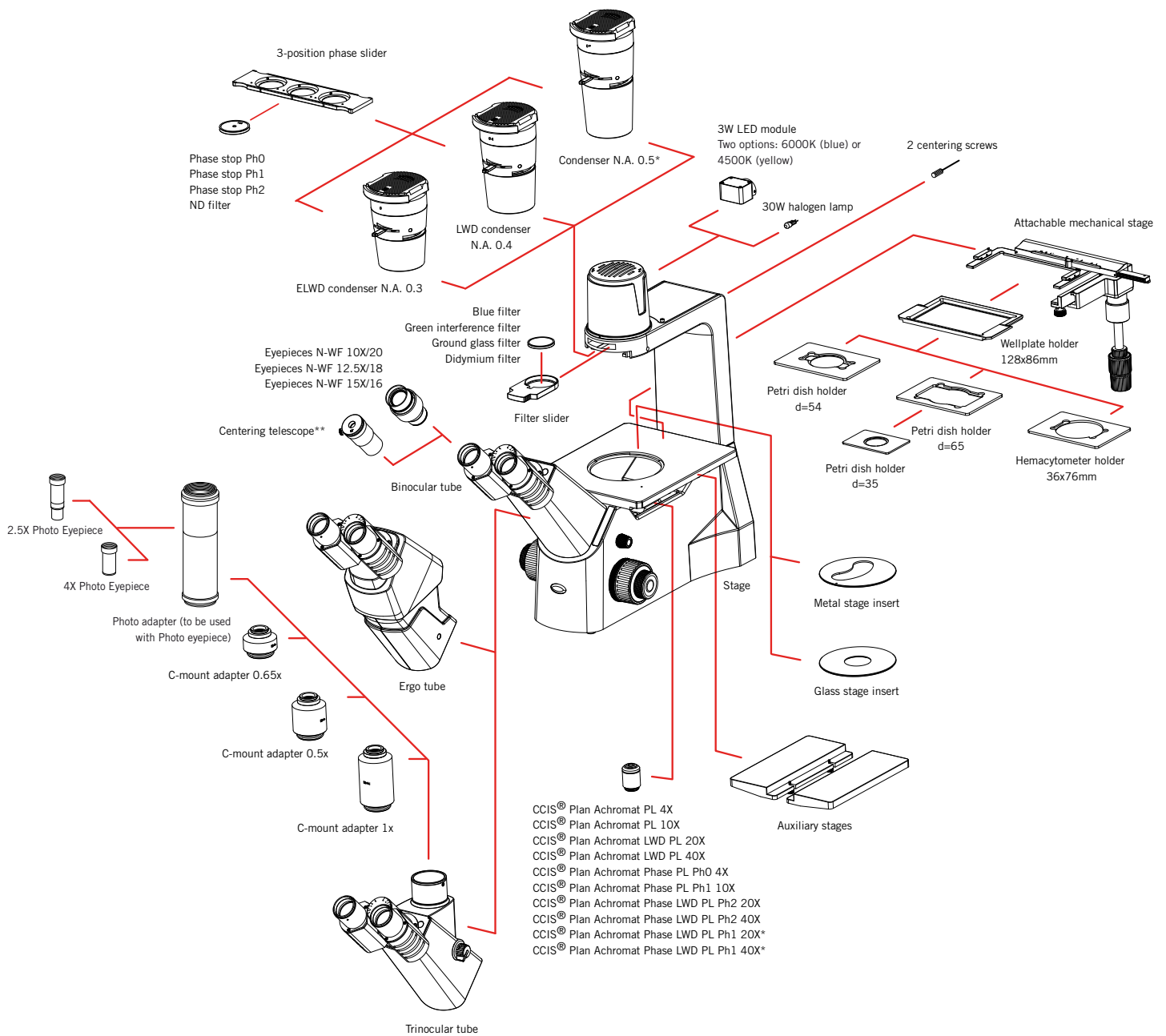

\* Will be released in 2011

\*\* For adjustment of Phase Contrast



Canada | China | Germany | Spain | USA

# Motic®

[www.motic.com](http://www.motic.com)

**Motic Instruments (CANADA)**

130 - 4611 Viking Way. Richmond, BC V6V 2K9 Canada  
Tel: 1-877-977 4717 Fax: 1-604-303 9043

**Motic Deutschland GmbH (GERMANY)**

Christian-Kremp-Strasse 11, D-35578 Wetzlar, Germany  
Tel: 49-6441-210 010 Fax: 49-6441-210 0122

**Motic Incorporation Ltd. (HONG KONG)**

Rm 2907-8, Windsor House, 311 Gloucester Road,  
Causeway Bay, Hong Kong  
Tel: 852-2837 0888 Fax: 852-2882 2792

**Motic Spain, S.L. (SPAIN)**

Polígono Industrial Les Corts, Camí del Mig, 112  
08349 Cabrera de Mar, Barcelona, Spain  
Tel: 34-93-756 6286 Fax: 34-93-756 6287

\* **CCIS®** is a trademark of Motic Incorporation Ltd.

**Motic Incorporation Limited Copyright © 2002-2011.  
All Rights Reserved.**

**Design Change :**

The manufacturer reserves the right to make changes in instrument design in accordance with scientific and mechanical progress, without notice and without obligation.



December 2010  
Designed in Barcelona (Spain)

